

**BKT**  
mobiliario  
urbano

Ficha Técnica  
Product Sheet

# MP-001

**Mesa Picnic** Picnic Table



## Estructura / Base Acero al Carbón

Carbon Steel Structure

## Asientos

Seats

## Cubierta

Table

## Color base

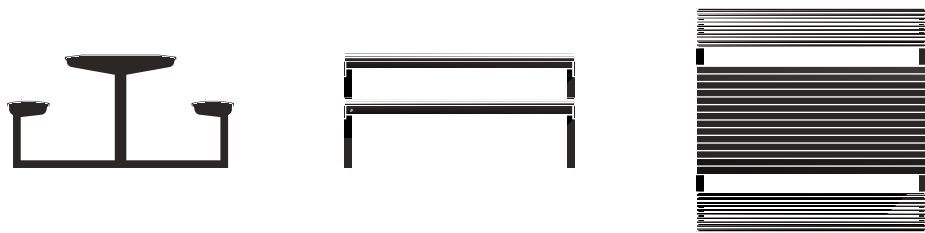

- Acero al carbón  
Carbon Steel

- Acero al carbón  
Carbon Steel

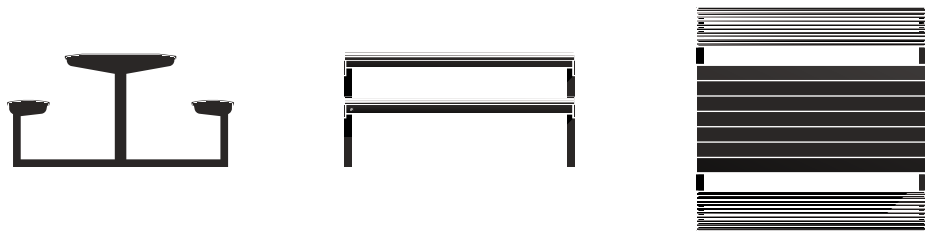

- Acero al carbón  
Carbon Steel

- Madera Tropical  
Tropical Wood



- Madera Tropical  
Tropical Wood

- Acero al carbón  
Carbon Steel



- Acero Inoxidable  
Stainless Steel

- Acero Inoxidable  
Stainless Steel



## Estructura / Base Acero Inoxidable

Stainless Steel Structure

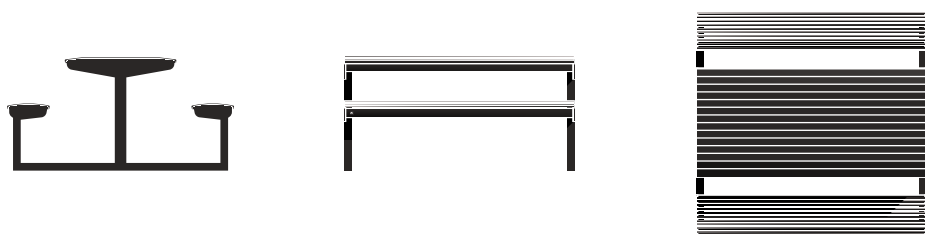

- Acero Inoxidable  
Stainless Steel

- Acero Inoxidable  
Stainless Steel

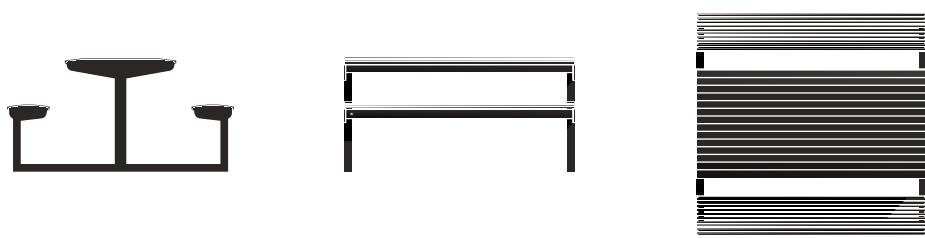

- Acero al Carbón  
Carbon Steel

- Acero al Carbón  
Carbon Steel

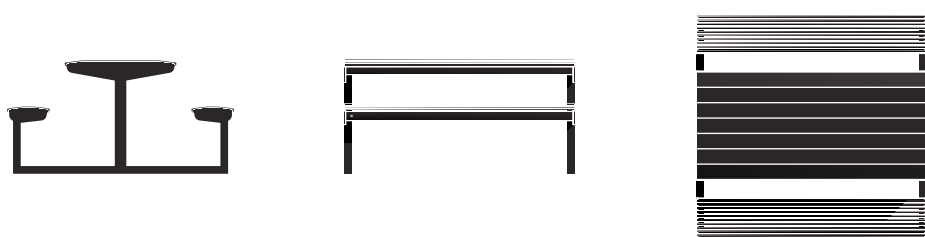

- Acero Inoxidable  
Stainless Steel

- Madera Tropical  
Tropical Wood

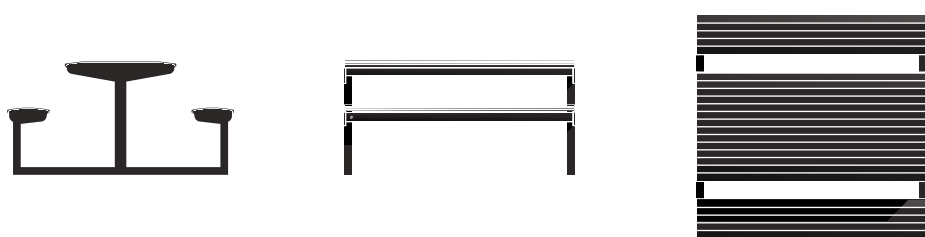

- Madera Tropical  
Tropical Wood

- Acero Inoxidable  
Stainless Steel

# MP-001



## Mesa Picnic Picnic Table

Altamente resistente y versátil, con opciones personalizables para las mesas, asientos y estructura, nuestra primer mesa picnic da la posibilidad al usuario de adaptarla a diversas condiciones de espacio, así como sus materiales la hacen resistente a adversidades climáticas y el uso intensivo.

The MP-001 is highly durable and versatile, with customizable parts: tables, seats, and structures. Our first picnic table allows users to adapt it to many space conditions. Its materials are weather-proof and designed for intensive use.

Peso Metal: 77 kg

Peso Madera: 73 kg

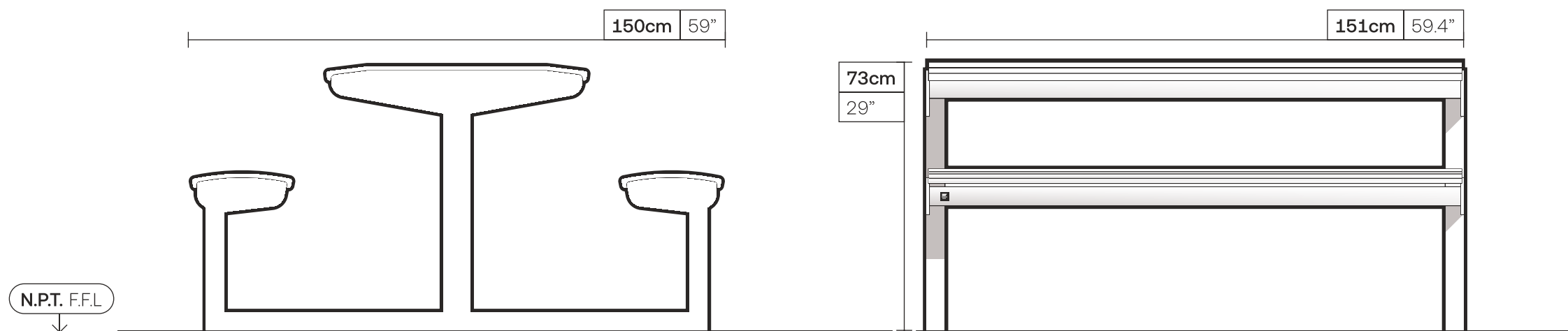

### Apariencia Appearance

#### Estructura Structure

- Acero al Carbón Carbon Steel
- Acero Inoxidable Stainless Steel

#### Asientos Seats

- Acero al Carbón Carbon Steel
- Acero Inoxidable Stainless Steel
- Madera Tropical Tropical Wood

#### Cubierta Table

- Acero al Carbón Carbon Steel
- Acero Inoxidable Stainless Steel
- Madera Tropical Tropical Wood

### Configuraciones Settings

#### Tamaños Sizes

- Único Default

#### Instalación Installation

- Taqueteable Fastened
- Ahogado Drowned

Para más información sobre las garantías, encuentralas en nuestro sitio web.

# Garantías

## Guarantees



### Zona Urbana

Urban Area

Se refiere a zonas de baja contaminación, secas y frías, de baja humedad o algunas zonas desérticas.

It refers to areas of low pollution, dry and cold, low humidity or some desert areas.



### Brisa Marina

Sea Breeze

Se refiere a embarcaderos o malecones con brisa de un grado muy alto de salinidad y neblina marina.

It refers to piers or promenades with very high levels of salt fog.



### Alta Humedad

High Humidity



Se refiere a zonas húmedas sin niebla salina o con grado medio de salinidad con cercanía a la costa.

It refers to humid areas without salt fog or with a medium degree of salinity close to the coast.

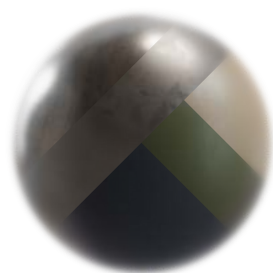

### Acero al Carbón

Carbon Steel

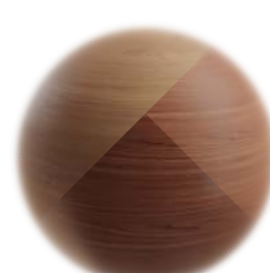

 60 meses months  
 12 meses months





 60 meses months  
 60 meses months  
 36 meses months

### Acero Inoxidable

Stainless Steel



 60 meses months  
 24 meses months  
 12 meses months



 [bkt\\_mobiliario.urbano](https://www.instagram.com/bkt_mobiliario.urbano)

[bktmobiliario.com](https://www.bktmobiliario.com)

 Herrera y Cairo 980  
Col. Jesús 44200  
Guadalajara, Jal. MX

 MiBici GDL-10  
 L1, Estación Refugio

 +52 33 3825 7333  
+52 33 3165 8582

 [info@bktmobiliario.com](mailto:info@bktmobiliario.com)