

**BKT**  
mobiliario  
urbano

Ficha Técnica  
Product Sheet

# BAN-005

**Banca** Bench



La alta capacidad de configuración de este producto ofrece opciones que abarcan una variedad de materiales, tamaños, colores y accesorios. Esto permite adaptarse a una amplia gama de requisitos específicos del cliente, la ciudad y el usuario. Cada variante de este producto se presenta en dos distintos tipos de instalación.

### Respaldo Acero al Carbón

Carbon Steel Backrest

#### Tipología

Typology

#### Dimensiones

Size

#### Color



Normal

63 / 120 / 78 cm

25 / 47 / 31 in



Mediano

97 / 120 / 78 cm

Medium

38 / 47 / 31 in

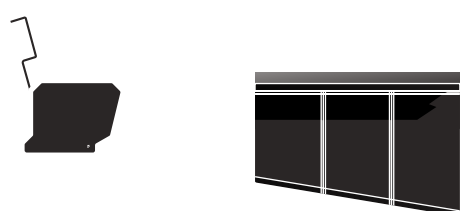

Grande

129 / 120 / 78 cm

Large

51 / 47 / 31 in



### Respaldo Acero Inoxidable

Carbon Steel Backrest

#### Tipología

Typology

#### Dimensiones

Size

#### Color



Normal

63 / 120 / 78 cm

25 / 47 / 31 in



Mediano

97 / 120 / 78 cm

Medium

38 / 47 / 31 in

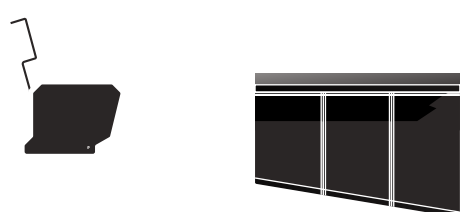

Grande

129 / 120 / 78 cm

Large

51 / 47 / 31 in



**Respaldo Madera**  
Carbon Steel Backrest

**Tipología**  
Typology

**Dimensiones**  
Size

**Color**



**Normal**

**63 / 120 / 78 cm**  
25 / 47 / 31 in



**Mediano**  
Medium

**97 / 120 / 78 cm**  
38 / 47 / 31 in

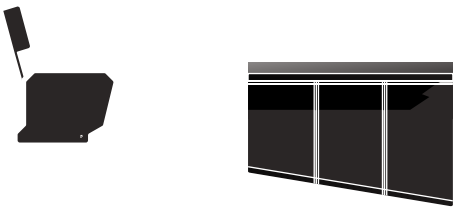

**Grande**  
Large

**129 / 120 / 78 cm**  
51 / 47 / 31 in



# BAN-005



## Banca Bench

Diseñado para espacios públicos y hecho de concreto polimérico de alta calidad para garantizar durabilidad y seguridad. Se presenta en múltiples tamaños y colores, brindando una estructura resistente y consistente para ofrecer longevidad en el entorno donde se inserte.

Designed for public spaces and made of high-quality polymer concrete to ensure durability and security. Presented in multiple sizes and colors, features a sturdy structure and impressive resistance for added safety and security, to offer longevity in any context where it is placed.

**Peso (M):**211 kg

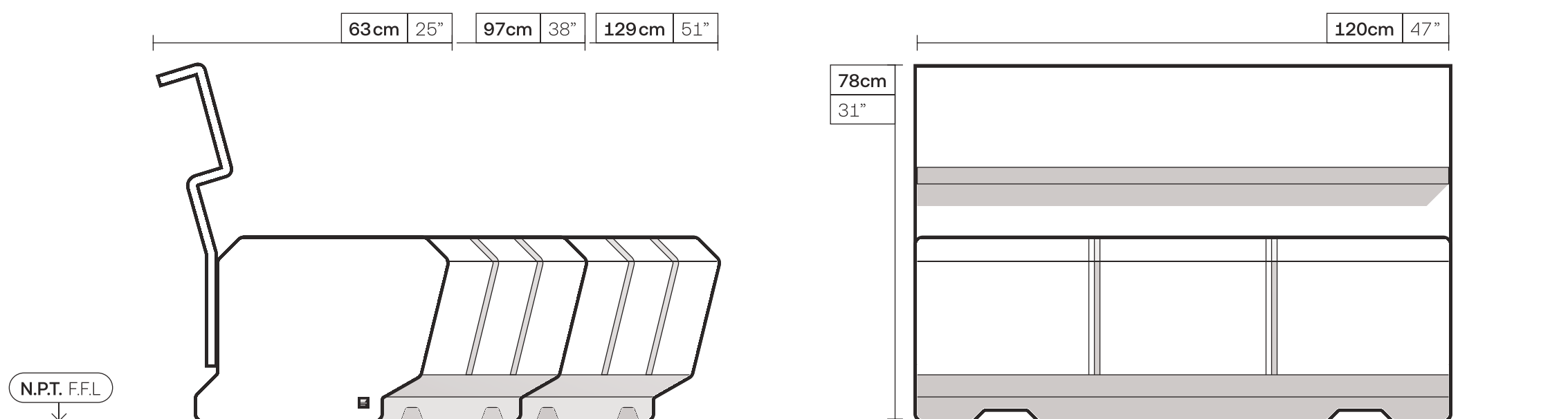

### Apariencia Appearance

#### Asiento Seat

- **Concreto Polimérico** Polymer Concrete



#### Respaldo Backrest

- **Acero al Carbón** Carbon Steel



- **Acero Inoxidable** Stainless Steel

#### Otros Others

- **Madera Tropical** Tropical Wood

### Configuraciones Settings

#### Tamaños Sizes

- **Chico** Small
- **Mediano** Medium
- **Grande** Large

#### Instalación Installation

- **Sobrepuesto** Laid



Para más información sobre las garantías, encuentralas en nuestro sitio web.

# Garantías

## Guarantees



### Zona Urbana

Urban Area

Se refiere a zonas de baja polución, secas y frías, de baja humedad o algunas zonas desérticas.

It refers to areas of low pollution, dry and cold, low humidity or some desert areas.



### Brisa Marina

Sea Breeze

Se refiere a embarcaderos o malecones con brisa de un grado muy alto de salinidad y neblina marina.

It refers to piers or promenades with very high levels of salt fog.



### Alta Humedad

High Humidity

Se refiere a zonas húmedas sin niebla salina o con grado medio de salinidad con cercanía a la costa.

It refers to humid areas without salt fog or with a medium degree of salinity close to the coast.

## Concreto Polimérico

Polymer Concrete

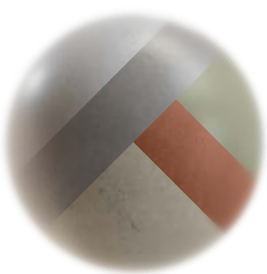

120 meses months  
 120 meses months  
 60 meses months

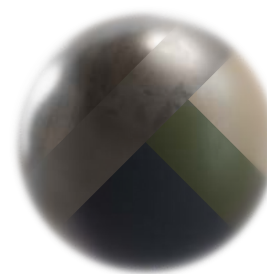

## Acero al Carbón

Carbon Steel

60 meses months  
 12 meses months

## Maderas

Woods



60 meses months  
 60 meses months  
 36 meses months



## Acero Inoxidable

Stainless Steel

60 meses months  
 24 meses months  
 12 meses months



 [bkt\\_mobiliario.urbano](https://www.instagram.com/bkt_mobiliario.urbano)

[bktmobiliario.com](https://www.bktmobiliario.com)

 Herrera y Cairo 980  
Col. Jesús 44200  
Guadalajara, Jal. MX

 MiBici GDL-10  
 L1, Estación Refugio

 +52 33 3825 7333  
+52 33 3165 8582

 [info@bktmobiliario.com](mailto:info@bktmobiliario.com)